

**SAFETY MANUAL
FOR
HISTORIC WEAPONS
PROGRAMS**



Pennsylvania
Historical & Museum
Commission

JANUARY 2018

TABLE OF CONTENTS

Introduction	4
Training	4
Event Liability Insurance	5
Minimum Age of Participants	5
Alcohol	5
Storage and Handling of Powder and Ammunition	6
Powder and Ammunition Storage Requirements	6
Responsibility of Safety Officer in Powder and Ammunition Storage	7
Magazine Inspection	7
Transfer of Powder and Ammunition	7
Preparation of Black Powder Ammunition	8
Weapons and Ammunition	8
Definitions: Small Arms and Artillery	8
Use of Original versus Reproduction Weapons	8
Required Safety Devices	9
Semi-automatic Blank Firing Adapters	10
Black Powder Small Arms Ammunition	11
Table of Maximum Black Powder Loads for Small Arms	11
Blank Metallic Cartridge Ammunition	12
Black Powder Artillery Charges	12
Table of Maximum Black Powder Loads for Artillery	13
Pistols	13
Automatic Weapons and LPG Guns	13
Blunderbusses and Shotguns	13
Smoke Grenades and Pyrotechnics	14
Rifle Grenades	14
Dummy Weapons, Airsoft Rifles, BB Guns, and CO2 Rifles	14
Edged Weapons	15
Clothing	15

Weapons Inspection Procedures	15
Black Powder Small Arms Inspection Procedures	15
Black Powder Small Arms Inspection Checklist	19
Black Powder Artillery Inspection Procedure	21
Black Powder Artillery Inspection Checklist	26
Post-1898 Small Arms Inspection Procedure	28
Post-1898 Small Arms Inspection Checklist	30
Visitor Safety and Conduct of Events	32
Weapons Handling in Camps	32
Barriers and Range Requirements	32
Small Arms Demonstrations	33
Artillery Demonstrations	34
Opposing Force Battle Reenactments	35
Firing Procedures & Personal Safety	36
Conduct of Firing Demonstrations - Black Powder Small Arms	36
Conduct of Firing Demonstrations - Black Powder Artillery	37
Conduct of Firing Demonstrations - Post-1898 Small Arms Demonstrations	40
Conduct of Opposing Force Reenactments	41
Use of Motorized Vehicles in Demonstrations and Reenactments	42
Equines, Livestock and Associated Equipment	43
General Rules	43
Picket Lines and Corrals	44
Equipment	45
Conduct of Calvary Demonstrations and Reenactments	45
Misfire Procedures	46
Glossary	48

INTRODUCTION

Military history is an important part of the Commonwealth of Pennsylvania's cultural heritage. Interpretive demonstrations featuring historic weapons have proliferated in response to the increased interest of reenactors, living historians, and the visiting public. The PHMC approves and supports the use of this interpretive method at its historic sites and museums provided that the programs are mission-appropriate, in compliance with PHMC safety rules and regulations, and the staff and volunteers supervising these activities are trained and certified by the PHMC. These interpretive demonstrations present the potential for accidents resulting in employee, reenactor, or visitor injuries and the resulting possibilities for tort claims and legal actions. To minimize the potential risk, a program of standards, training, certification and inspection has been developed and implemented. The following regulations govern the interpretive use of historic weapons at the historic sites and museums under the PHMC's jurisdiction. The regulations deal with staff training requirements, ammunition and black powder storage, weapons safety, and the safe conduct of historic weapons demonstrations and reenactments.

These regulations represent the minimum acceptable PHMC standard. In certain situations, and at specific historic sites and museums more stringent regulations may be required. These additional requirements may be developed and implemented by individual Site Administrators, Site Safety Officers, or by the Bureau of Historic Sites and Museums itself.

It is the policy of the PHMC to comply with all State, Federal, and local safety codes and regulations governing the storage and handling of munitions and firearms. This includes the regulations of the Occupational Safety and Health Act, the Bureau of Alcohol, Tobacco and Firearms (BATF), and the PA Department of Conservation and Natural Resources (DCNR). If any of the above regulations differ, the PHMC and its historic sites and museums will comply with the more stringent regulations.

TRAINING

The Pennsylvania Historical and Museum Commission will certify staff and volunteers in the safe use and handling of historic weapons for demonstration purposes. The Historic Site

Administrators or directors of PHMC sites where demonstrations and reenactments occur are required to be certified by the PHMC in historic weapons safety. Any on-site employees designated by the Site Administrator to be in charge of weapons demonstrations are also required to be first certified by successfully completing the PHMC Historic Weapons Safety course. Updates and training in small arms and artillery safety will be provided to safety officers and volunteers who monitor PHMC events. PHMC sites or museums where the Site Administrator or director has not been certified in historic weapons safety by the Commission may not conduct demonstrations, battles, or programs involving the use of historic weapons.

EVENT LIABILITY INSURANCE

Events involving firing demonstrations licensed to the associates group must be covered by the associate group's liability insurance. At sites where there is no associate group or where the PHMC is using the reenactors as volunteers in state service, the PHMC will insure the event and all state laws and regulations governing volunteers on Commonwealth property will apply. All such volunteers will be required to sign in when they arrive at the historic site or museum to provide service.

In cases where a group or individual is using the site for a historic weapons-related purpose other than a site or PHMC-sponsored program, they must supply insurance as per the Facility Use Program guidelines.

MINIMUM AGE OF PARTICIPANTS

Participants must be a minimum of 17 years of age to carry and use a weapon (functional or otherwise) in demonstrations or opposing force reenactments.

ALCOHOL

Alcoholic beverages will not be distributed or sold at PHMC historic sites and museums during events featuring historic weapons activities.

STORAGE AND HANDLING OF POWDER AND AMMUNITION

As a general rule, black powder, ammunition, and related explosives will not be stored at historic sites and museums administered by the PHMC except during the period twenty-four hours prior to, during, and twenty-four hours after scheduled historical firing demonstrations are being conducted. The long-term storage of powder and ammunition on PHMC property is to be avoided whenever possible.

Only PHMC staff may prepare and fill black powder charges and cartridges on PHMC property. Demonstrators or reenactors not directly employed by the PHMC may only bring pre-made black powder cartridges, artillery charges, and commercially-manufactured blank metallic cartridge ammunition onto the site. Such ammunition will remain in the possession of the demonstrators and reenactors until use. Demonstrators and reenactors may not store powder and ammunition in PHMC magazines.

Powder and Ammunition Storage Requirements

Bulk black powder in amounts in excess of 5 lbs. and blank metallic cartridge ammunition for use by PHMC staff shall be placed in a minimum Type 3 BATF magazine secured in an uninhabited building immediately upon arrival at the site by the certified site Safety Officer. All powder and ammunition shall remain in the magazine until the time of the demonstration.

In cases where firing demonstrations are scheduled on successive weekends up to 10 lbs. of black powder may be stored at a PHMC site in a minimum Type 3 BATF magazine that has been secured in an uninhabited building.

Visitor Centers and administrative offices shall at all times be considered “inhabited buildings.” No portion of these buildings shall be used for storage of black powder, ammunition, or other explosive devices or for loading operations using these materials. In cases where a site or

museum has no uninhabited non-historic buildings it will be necessary to construct and locate a small outdoor magazine as per current BATF regulations and the American Table of Distances.

Under special circumstances and with the expressed written permission of the PHMC Executive Director up to 50 lbs. of black powder may be stored at a PHMC site for a period of 6 months provided the following conditions are met:

- 1) Powder is stored in a Type 4 BATF permanent or mobile magazine
- 2) The magazine is inspected weekly and a written record kept per BATF regulations
- 3) The powder is used only for Commission-sponsored demonstrations
- 4) Ignition primers are stored in a separate type 4 BATF magazine

Responsibility of Safety Officer in Powder Storage

Storage of black powder and other related explosives on PHMC historic site or museum property will be under the supervision of an officially trained and certified Safety Officer who has been designated in writing by the PHMC to be responsible for the enforcement of safety precautions. An alternate Safety Officer shall also be designated by the PHMC to act during any temporary absence of the certified Safety Officer.

Magazine Inspection

Regular weekly inspections of the magazine will be conducted. Black powder containers are to be dated with the oldest powder being used first.

Transfer of Powder and Ammunition

Removal of black powder from the magazine shall be in a spark-proof pass box. The pass box will be suitable for all black powder materials including loaded paper cartridges, powder horns, flasks, quill primers and assembled artillery charges. Ammunition may be transferred from the pass box to suitable historical containers such as cartridge boxes or limber chests for

demonstration purposes. All ammunition not used in the demonstration will be immediately returned to the pass box, and ultimately, the magazine.

Preparation of Black Powder Ammunition

Only PHMC staff may prepare and fill black powder cartridges on PHMC property. Demonstrators and reenactors not directly employed by PHMC may only bring pre-made cartridges and charges to the site. Ammunition loading areas will be in an uninhabited building located at least 50 feet away from the storage magazine. There will be a non-sparking work table, adequate spark-free lighting, non-sparking floor surface, and a secure entrance controlled by the person handling the black powder. Loading areas will be cleaned frequently with water to prevent the accumulation of black powder dust. In cases where the site or museum does not have a building that is suitable for preparing ammunition, a secluded portion of the site may be secured using ropes or other means. The location should be at least 100 yards distant from any areas frequented by the public. A spark-proof work surface (wooden table for example) or another suitable alternative must be provided. The amount of powder to be removed from the pass box for the purpose of preparing ammunition is restricted to a maximum of 1 lb. at a time.

WEAPONS AND AMMUNITION

Definitions - Small Arms and Artillery

Rifles, muskets and pistols with a bore of one inch or less are defined as *small arms*. Weapons with larger bore diameters are defined as *artillery*. Rifle grenades will be considered artillery for the purposes of range safety requirements.

Use of Original versus Reproduction Weapons

Small arms and artillery intended for use on PHMC property that are representative of historical periods dating prior to 1898 shall be reproduction weapons only. Original weapons manufactured

in 1898 or later may be used in correct historic period demonstrations or reenactments provided they first pass a PHMC weapons safety inspection.

Required Safety Devices

All flintlock small arms shall be equipped with flash guards and hammerstalls (frizzen covers). Frizzens and cocks will be kept in the full forward position until the weapon is readied for loading. For percussion small arms, no percussion cap (expended or otherwise) shall be fixed upon the nipple except when the weapon is being prepared to fire. Cartridge weapons will remain unloaded with the breech closed and safety locks engaged or with the hammer in its safety position until the weapon is being prepared to fire.

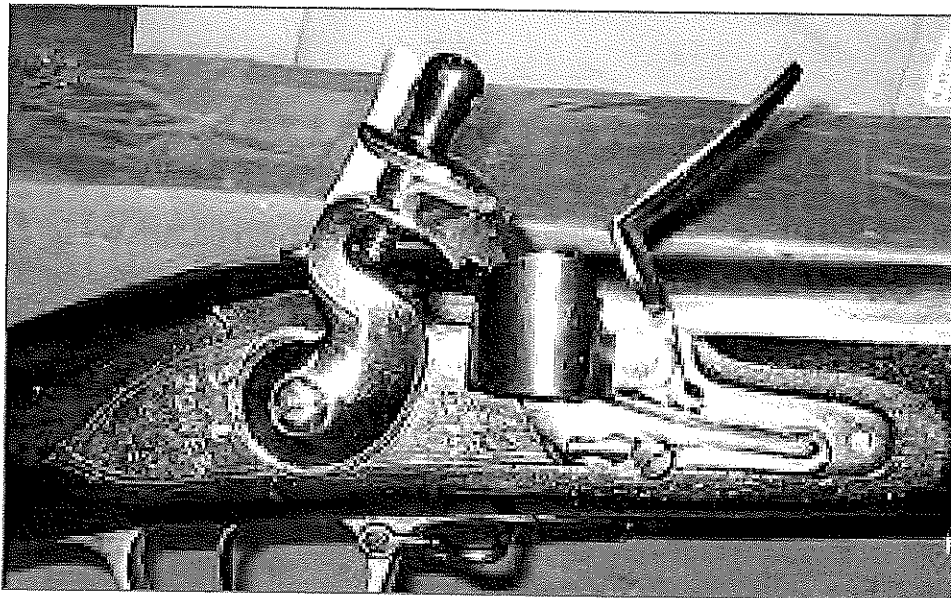

Fig. 1 Flash guard installed on reproduction Brown Bess musket

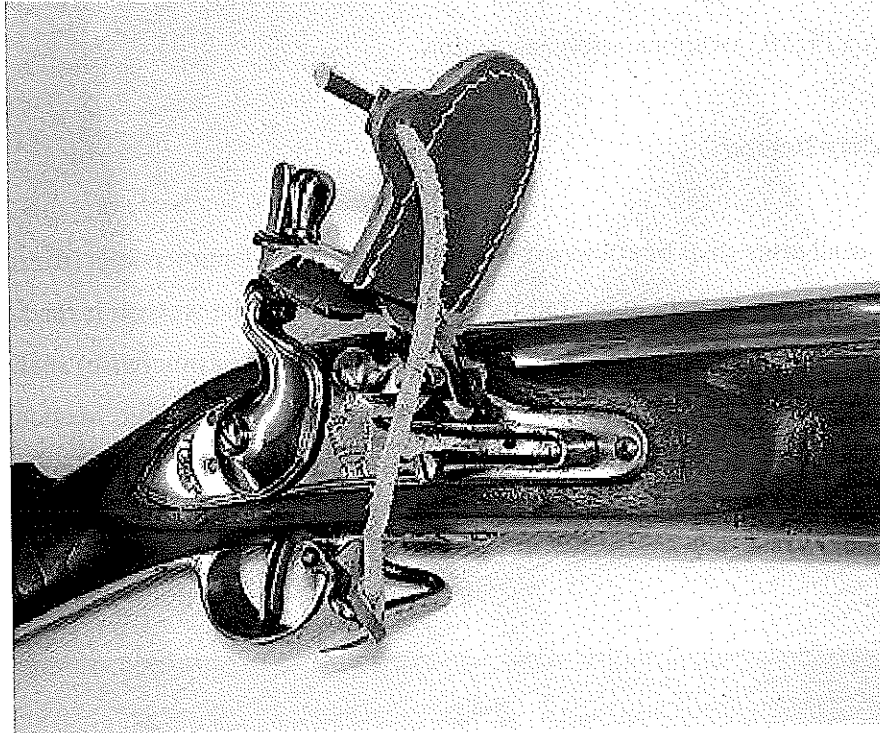

Fig. 2 Frizzen cover or hammerstall

Semi-Automatic Blank Firing Adapters

Only threaded barrel-type blank firing adapters (i.e. “Hollywood-style BFAs”) may be used on post-1898 era weapons (Fig. 3). Exterior barrel-mounted BFAs that clamp onto the barrel and shredder-type BFAs are not permitted (Fig. 4).

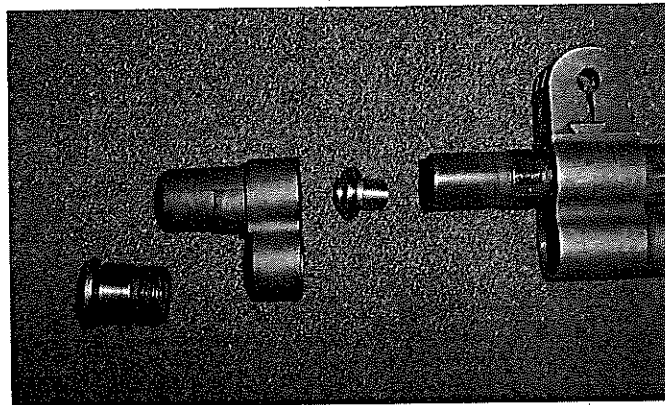

Fig. 3 Threaded “Hollywood” type blank firing adapter for M1 Garand

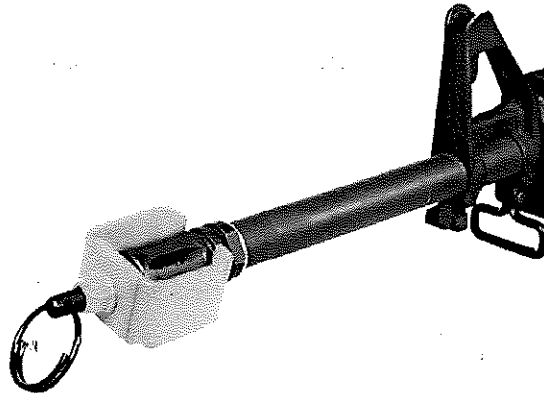

Fig. 4 Exterior barrel-mounted blank firing adapter

Black Powder Small Arms Ammunition

Only powder and ammunition appropriate for the weapon types in question shall be used. Smokeless powder is not to be used in a black powder weapon, etc. Cartridges for muzzle loading black powder small arms will be made of paper - no staples or other metallic fasteners are to be used.

Table of Maximum Black Powder Loads for Small Arm Cartridges		
Weapon Type	Caliber	Maximum
18th Century Small Arms		
Brown Bess Musket	.75	125 grains
Charleville Musket	.69	125 grains
Pennsylvania Rifle	varies	90 grains
Pistols	varies	90 grains
19th Century Small Arms		
U.S. Rifle 1841	.58	60 grains
U.S. Rifle Musket	.58	60 grains
British Enfield	.58	60 grains
Musketoon	.58	60 grains
U.S. Musket 1842	.69	75 grains
19th Century Metallic Cartridge Small Arms		
U.S. Springfield Rifle	.50	70 grains
Sharps Carbine	.50	55 grains
U.S. Springfield Rifle	.45	70 grains
U.S. Springfield Carbine	.45	55 grains
Colt Revolver	.45	28 grains

Blank Metallic Cartridge Ammunition

Blank metallic cartridges will be of commercial manufacture and of the star crimped-type only. Blank cartridges containing any type of ersatz projectile or bullet (wax, wood, plastic, rubber), including wooden-tipped blanks for use in shredder-equipped weapons are not permitted. Use of military blank rounds designed for grenade-launchers for other purposes is not permitted. All blank metallic cartridges must be inspected by a certified Safety Officer prior to use.

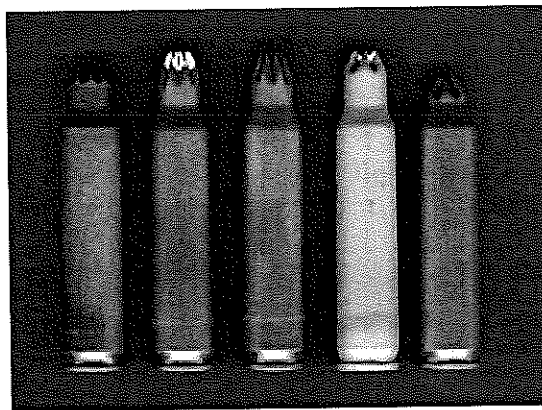

Fig. 5 Star-crimped-type blank metallic cartridges

Use of damaged or corroded blank ammunition is not permitted. All failed ammunition will be collected by the senior NCO of the respective reenactment unit and secured until after the event.

Possession of live ammunition on PHMC property by program participants for any purposes is strictly forbidden. Ammunition and explosive devices utilized for display purposes, whether antique or otherwise, must be commercially-manufactured blanks, dummy rounds or demilitarized.

Black Powder Artillery Charges

The use of fused artillery munitions and pyrotechnics is not permitted. Artillery charges will be prepared with black powder loads as specified in the table below.

Table of Maximum Loads for Artillery		
Weapon Type	Caliber	Maximum
Grasshopper	3 Pounder	8 ounces fg
British Light 6	6 Pounder	12 ounces fg
British Field Howitzer	5.8 inch	10 ounces fg
Iron Gun	3 Pounder	10 ounces fg
Iron Gun	4 Pounder	10 ounces fg
Iron Gun	6 Pounder	10 ounces fg
Howitzer	8 inch	36 ounces fg
Howitzer	8.76 inch	16 ounces fg
Iron (Armstrong)	9 Pounder	24 ounces fg
Iron (Armstrong)	18 Pounder	32 ounces fg
Iron (Armstrong)	24 Pounder	36 ounces fg
Napoleon	12 Pounder	20 ounces fg
M1841 Howitzer	12 Pounder	10 ounces fg
Mountain Howitzer	12 Pounder	6 ounces fg
Gun 1841	6 Pounder	10 ounces fg
Parrott Rifle	3 inch	10 ounces fg
Ordnance Rifle	3 inch	10 ounces fg

Black powder artillery charges will be made of foil or paper only (plastic is not permitted) and are only to contain black powder. Pyrotechnic additives intended to provide heavier smoke or louder reports are not permitted.

Pistols

Pistols may be used in in non-opposing force demonstrations and battle re-enactments provided small arms range requirements are met. Pistols are not to be discharged within 25 yards of opposing forces.

Automatic Weapons and LPG Machine Gun Simulators

Fully-functional automatic weapons are not permitted on PHMC property.

Demilitarized automatic weapons rendered inoperable may be used for display provided a PHMC safety inspection verifies their demilitarized status.

Commercially-manufactured semi-automatic versions of historic automatic weapons are permitted provided a PHMC safety inspection verifies semi-automatic-only function.

Liquid propane gas (LPG) weapon and machine gun simulators are permitted provided a PHMC safety inspection verifies safety and functionality. All oxygen and propane tank connections will be checked and the weapon test-fired to prove safety and functionality. Standard small arms range requirements apply.

Shotguns, Blunderbusses and Wall Guns

Shotguns, blunderbusses and fortification-style wall guns may be utilized in non-opposing force demonstrations only. Standard small arms range requirements apply.

Smoke Grenades and Pyrotechnics

The use of smoke grenades, smoke generators, and artillery simulators by reenactors is not permitted. PHMC staff may employ smoke grenades in demonstrations and reenactments provided the devices are commercially-manufactured and staff so engaged hold current PHMC Historic Weapons Safety certification. No other pyrotechnics, fused munitions or artillery simulators are permitted.

Rifle Grenades

Rifle grenades may be employed in non-opposing force demonstrations only. Rifle grenades are considered artillery for the purposes of range safety requirements.

Dummy and Demilitarized Weapons, Airsoft Rifles, BB Guns and CO₂ Rifles

Dummy and demilitarized weapons are subject to the standard safety inspection requirements to verify that they are non-operational. Airsoft rifles, BB guns and CO₂ rifles are not permitted for use or display.

Edged Weapons

Edged weapons (bayonets, fighting axes, swords, pikes, knives, etc.) must be properly sheathed. Edged weapons may be employed in non-opposing force demonstrations. Apart from the use of swords by officers to direct troops, edged weapons are not to be drawn or brandished in opposing force reenactments. Close combat with edged weapons is prohibited.

Clothing

For protection from flash burns clothing worn by demonstrators firing black powder weapons should be made of natural fibers - long-sleeved outer garments or full uniforms appropriate to the historical period are recommended. In addition, leather gauntlets shall be worn by the artillery crew members that sponge and ram artillery pieces, insert ammunition, and work to correct misfires.

WEAPONS INSPECTION PROCEDURES

Each weapon intended for use in demonstrations and battle reenactments at a PHMC historic site or museum must first pass a safety inspection. The following pages contain the inspection procedures which must be followed for each category of weapon. Weapons must be inspected at least once each day prior to being fired for the first time – ideally each weapon should be re-inspected prior to subsequent engagements. As a suggestion, a small “dot” sticker may be applied to the bottom of the trigger guard to indicate that the weapon has passed inspection. The stickers may vary in color from day to day.

Black Powder Small Arms Inspection Procedures

It is not necessary nor recommended that PHMC Safety Officers physically handle the weapons being inspected. As best practice, it is recommended that the owner of the weapon maintain possession and control of the weapon at all times, demonstrating the safety and functionality of

the weapon, ammunition and equipment to the Safety Officer in response to spoken commands. Typically, those commands are given by the commanding officer of the respective reenactment unit. The suggested format is as follows:

- 1) Inform the duty officer of the unit to be inspected that you would like him to conduct a weapons inspection of his troops under your observation. Advise him to muster the men who will be participating in the demonstrations and tactical maneuvers and ask him to conduct the inspection in the following or similar manner:
- 2) “SECURE ARMS” - This is the act of inverting the weapon towards the ground, barrel pointed downwards, to ensure that no objects or powder are loose in the weapon.
- 3) “SEARCH ARMS” - This involves removing the ramrod and sliding it down the barrel so that it makes contact with the breech, verifying that the weapon is unarmed. If the rammer is made of steel this should produce a “ping” sound. Wooden rammers do not make this sound. The amount of ramrod that remains visible beyond the end of the barrel when the ramrod is inserted may also be used as an indication of the presence of a possible charge or object in the barrel.
- 4) “POISE FIRELOCK” - The weapon is presented to the inspecting officer with the lock at eye level and facing the inspector. It is at this point that the inspecting officer and the safety officer should observe each weapon for physical defects or dangerous powder build-up between the lock-plate, pan, and barrel. These parts should all be securely fitted with only hairline gaps showing between the metal and wood areas. Key inspection points are:
 - a. No original weapons allowed on the field.
 - b. All weapons will have flash guards mounted through the frizzen screw.
 - c. The frizzen will function smoothly.
 - d. Weapons have “hammerstalls” or frizzen covers that cover the metal surface of the frizzen.
 - e. All fittings and furniture are present.

- f. No cracks or gouges are visible in the musket or rifle stock indicating structural weakness or damage

At the end of the inspection have the troops bring all hammers to the half-cock position.

5) "HANG FIRELOCK" - Have the inspecting officer instruct the troops to place their right thumb inside the trigger guard, rotate the barrel to the right and let the weapon hang on the thumb so that the weight of the weapon is on the trigger mechanism. Any discharge of the lock on half-cock (safety) causes the weapon to fail the inspection. Some safety officers and commanders prefer to have the reenactor individually test the trigger of the weapon directly with a stronger than normal pull on the trigger to ensure that that it will not fire at the half-cock position. This is acceptable provided the weapon remains pointed in a safe direction during the test.

6) "PRESENT CARTRIDGES" - While remaining in ranks, the reenactors will be instructed to present a sample black powder cartridge for visual inspection by the Safety Officer. The cartridge will be visually inspected to ensure it does not contain a projectile, contains the appropriate powder charge, and has been properly assembled.

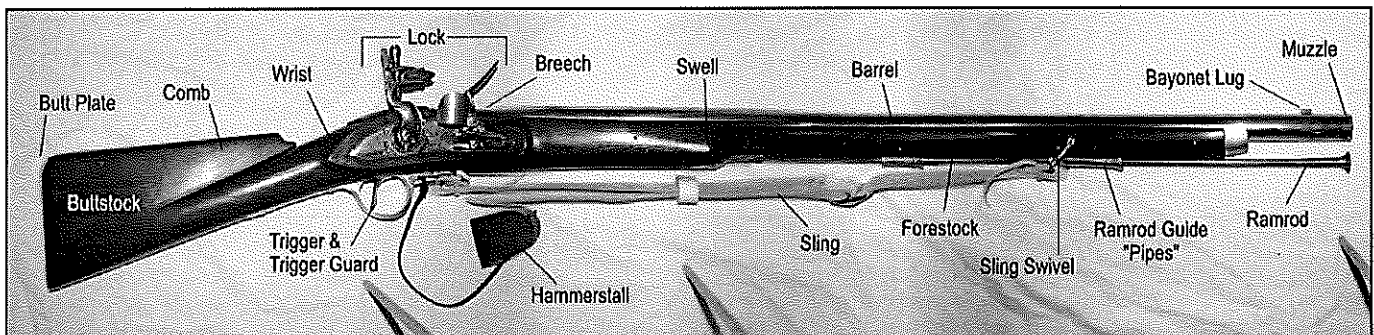

Fig. 6 Parts of a Black Powder Flintlock Musket

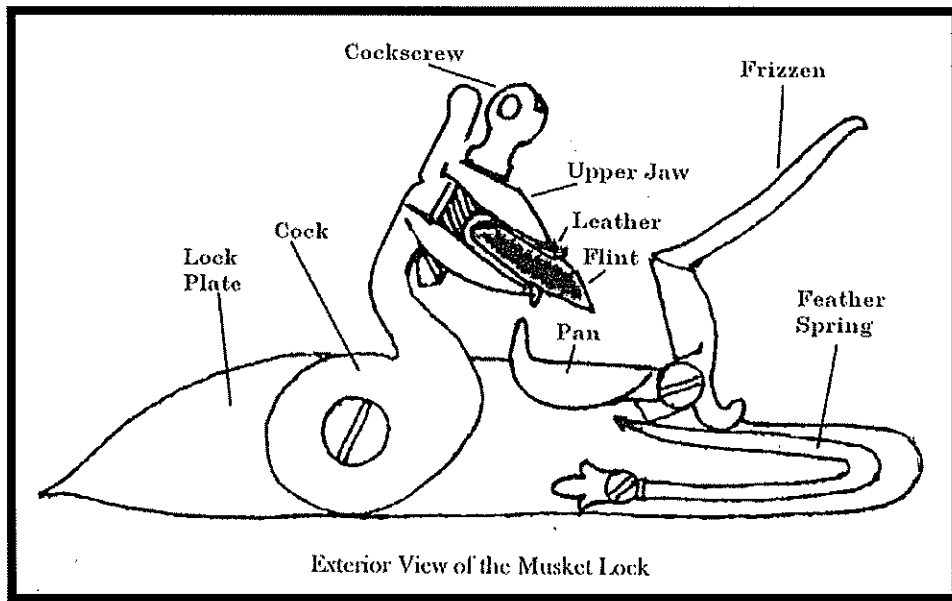

Fig. 7 Parts of a Musket Lock

Black Powder Small Arms Inspection Checklist

Pre-Disassembly (for all weapons)

- () The weapon is confirmed to be unloaded.
- () Your overall first impression is favorable.

The Stock

- () No cracks, splits, splinters or rough edges.
- () Butt plate, trigger guard, etc., fit tightly.
- () No burrs on butt plate or trigger guard screw heads.
- () If band springs are present they work smoothly.
- () If stock is pin-fastened, all pins are there, tight and wood is not splintered.
- () No burns visible around the top of lock that can cause the weapon to fail.
- () Two-piece stocks have sections securely joined.

The Lock

- () Lock works smoothly.
- () Hammer of cock fits tightly on tumbler.
- () All hammer positions are firm and solid.
- () Half-cock position works properly.
- () When trigger is pulled, it works properly releasing the cock cleanly.
- () Trigger pull is proper. If it feels light, a scale may be used to ensure that not less than three pounds of pull is required to release trigger.
- () Set triggers are properly adjusted and work smoothly.
- () Lock fits snugly into stock and pan is tight against barrel. No powder can fall between lock and barrel.
- () Striking face of a percussion hammer is not battered. It strikes the cap squarely and in the center.
- () Lock jaws grip flint securely.
- () There is a proper leather or lead flint wrap.
- () The flint is in good condition and installed at the proper angle.
- () Frizzen is in working order.
- () Frizzen is in good condition and not gouged or cracked.
- () Pan is clean and properly aligned with vent hole.

The Barrel

- Barrel fits stock.
- Barrel is free from dents or cracks.
- Flint does not strike the barrel.
- Muzzle not dented or worn.
- Nipple or cone on percussion weapons is well-seated and not battered.
- On percussion weapons, hole is clear and of proper size. The shoulders are not worn down.
- On firelocks, vent is clear and of proper size.
- No signs of heavy corrosion around vent or cone.
- Sights, if extant, are complete and operable.
- Barrel bands or pins hold barrel securely.
- Ramrod is straight, fits the stock properly, and the threads at the lower end are clean and free of burrs.

Edged Weapons

- Verify that all knives, sabers, swords, bayonets in the proper scabbards.
- Verify that the edges and tips of display edge weapons are blunt.

Black Powder Artillery Inspection Procedures

Each artillery piece intended for use in demonstrations and battle reenactments at a PHMC historic site or museum must first pass a safety inspection. Weapons must be inspected at least once each day prior to being fired for the first time – ideally each weapon should be re-inspected prior to subsequent engagements.

- 1) Verify that the artillery piece has a full crew – for a field piece this is five members. It is recommended that the crew run be out through their firing drill for the benefit of the Safety Officer prior to inspection to ensure that the crew is properly trained, organized and equipped.
- 2) Verify bore and vent of the artillery piece are clean and clear of all foreign matter prior to inspection.
- 3) Inspect the bore – ensure liner (if present) remains firmly attached, no gaps, visible damage to gun tube, etc.
- 4) Check and make sure all bolts and fixtures on the gun carriage are tight. Make sure the trunnion caps and pins are tight and held properly in place by cotter pins or other acceptable fasteners.
- 5) Verify carriage is in good condition – no visible splintering, checking or wood rot.
- 6) Inspect wheels for rot, splintering, damage to hub or axle that might lead to failure of wheel, axle, etc.
- 7) Inspect tools and equipment:
 - a. Vent brush is in good condition with bronze, brass, or copper bristles.
 - b. Vent pick should have a sharp point to assure a good puncture of the round to prevent a misfire and should be clean of all gunpowder.
 - c. Lanyard is in good condition and constructed of non-elastic material.

- d. Sponge head material should be in good condition and secured to the sponge head securely. The sponge head should fit the bore in a manner that creates a proper vacuum when extracted (not too loose or too tight).
 - e. Worm is in good condition, tips are sharp enough to remove remains of any spent rounds. The worm head should be securely tightened to the shaft and the prongs properly angled out beyond the surface of the worm coil.
 - f. Rammer is in good condition free of cracks, splits, splintering, etc.
 - g. Loader and rammer are outfitted with heavy leather "welder style" gauntlets (gloves) that are in good condition.
 - h. Leather thumbstall is clean, in good condition, capable of securing the vent as required.
- 8) Limber chest outfitted with a workable lock to secure the ammunition box. Lid of limber chest has a self-closing mechanism (chain).
- 9) The ammunition box should be properly constructed and lined with non-ferrous materials, clean and free of all loose gunpowder. Primers are securely stored in a separate container away from the rounds.
- 10) Chocks are available to chock both the gun wheels and limber wheels.
- 11) Vent flushing apparatus (syringe, pressurized fire extinguisher, etc.) is available in the event a round needs to be flushed or cleared from the barrel.

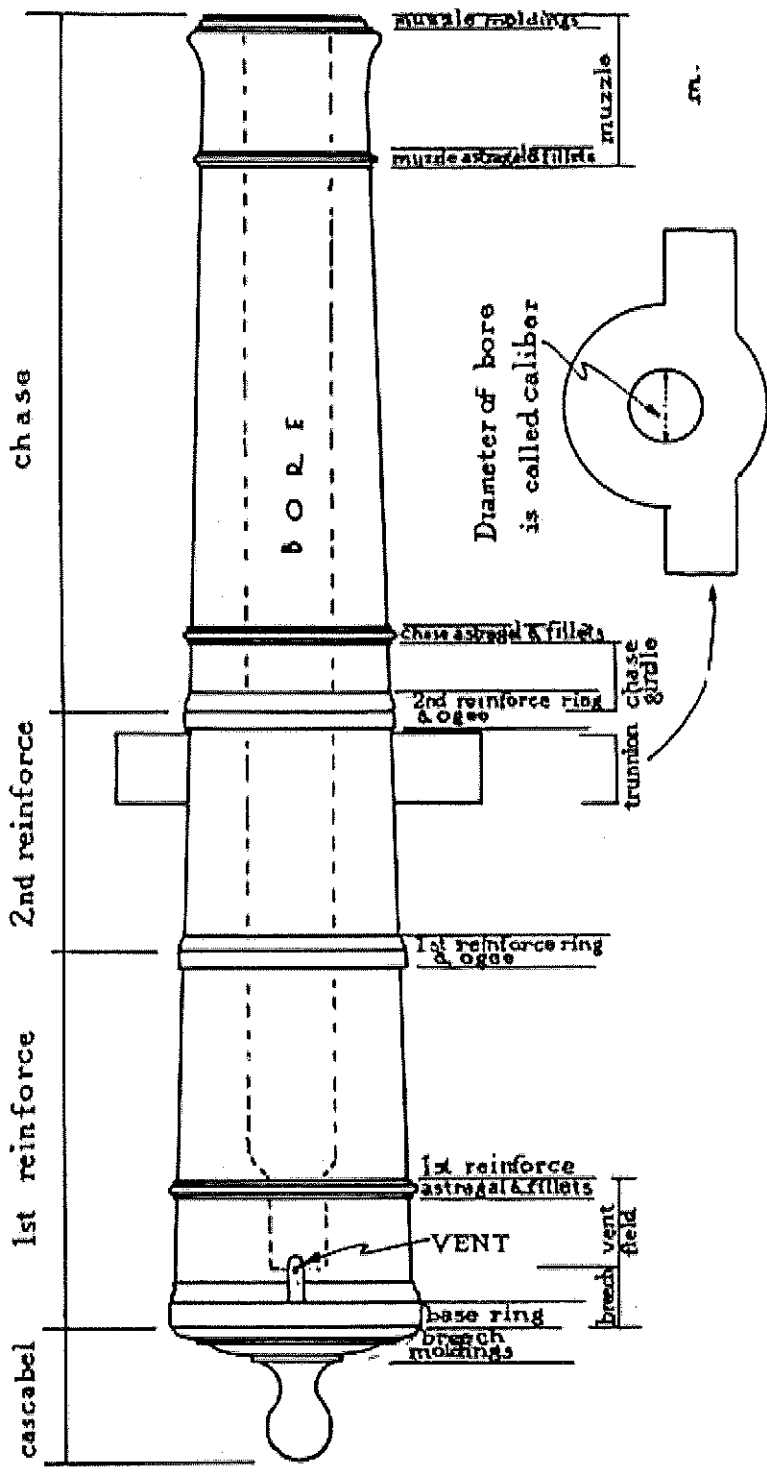
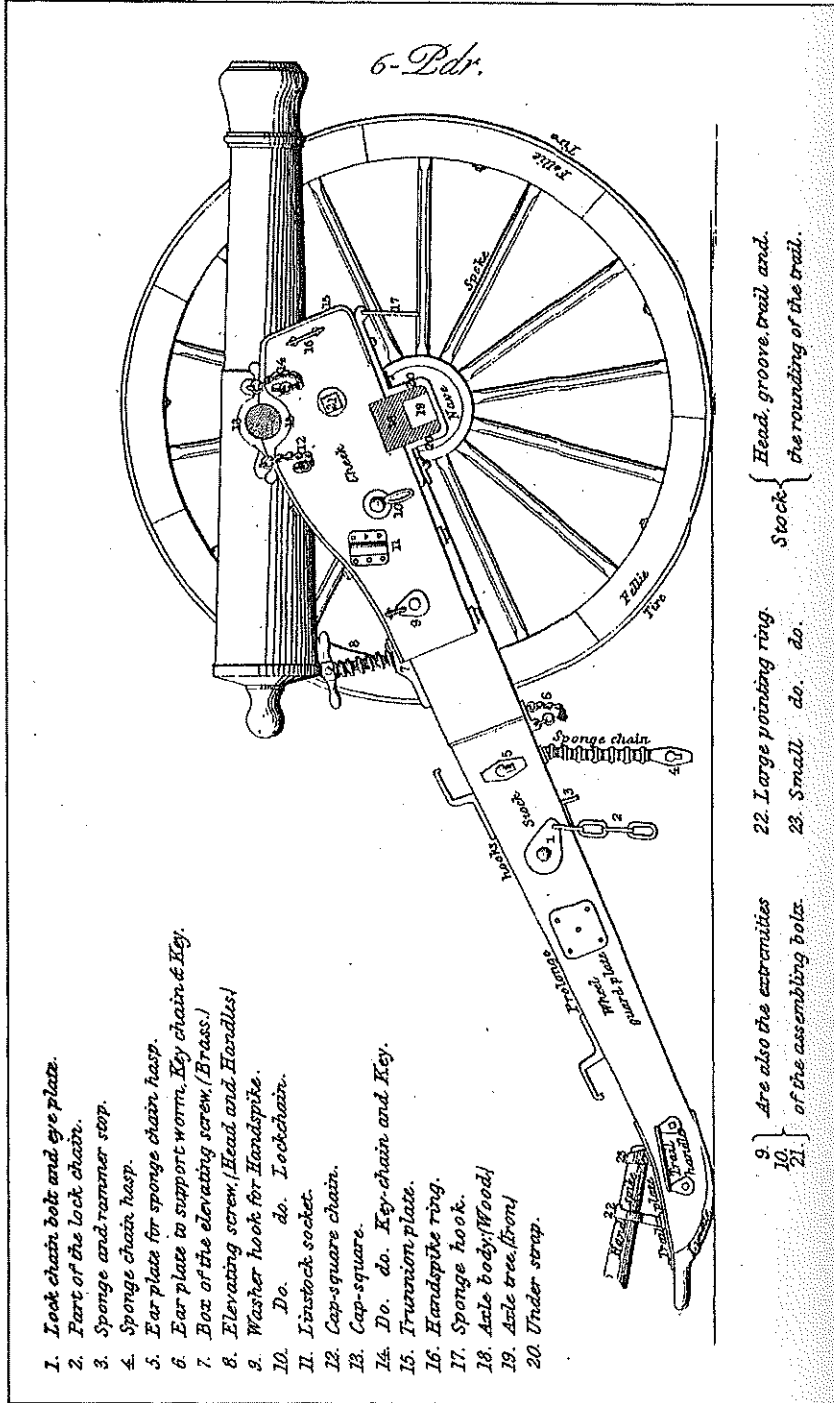

Fig. 7 Basic parts of a cannon tube

Nomenclature.

Plate 8.



1. Lock chain bolt and eye plate.
2. Part of the lock chain.
3. Sponge and rammer stop.
4. Sponge chain hasp.
5. Ear plate for sponge chain hasp.
6. Ear plate to support worm. Key chain & Key.
7. Box of the elevating screw. (Brass.)
8. Elevating screw. (Head and Handles)
9. Washer hook for Handspike.
10. Do. do. Lockchain.
11. Linstock socket.
12. Cap-square chain.
13. Cap-square.
14. Do. do. Key-chain and Key.
15. Trunnion plate.
16. Handspike ring.
17. Sponge hook.
18. Axle body. (Wood)
19. Axle tree. (Iron)
20. Under strap.

22. Large pointing ring.
 23. Small do. do.
9. } Are also the extremities
10. }
21. }
- Stock { Head, groove, trail and
 the rounding of the trail.

Fig. 8 Parts of a Civil War-era artillery carriage

Nomenclature.

Plate 9.

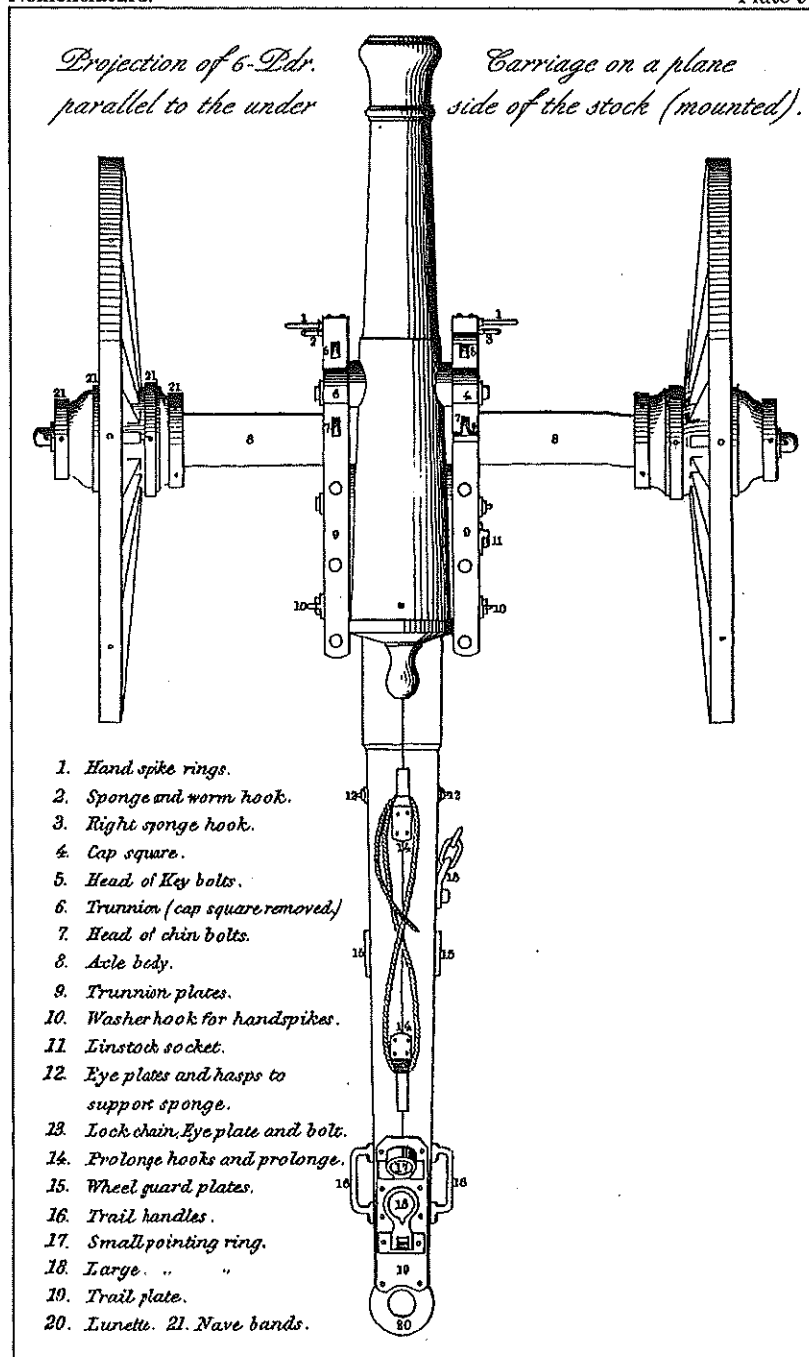

Fig. 9 Parts of a Civil War-era artillery carriage

Black Powder Artillery Inspection Checklist

Before Disassembly (for all weapons)

- () Your overall first impression is favorable.

The Tube

- () Tube is clean and free of rust or corrosion.
- () No sign of external damage or strain (dents, cracks, etc.)
- () Inside of the bore is clean and relatively smooth.
- () No internal signs of damage (bulges, lodgments, pits, etc.)
- () No sign of corrosion damage at breech of the bore.
- () On modern iron guns with liners, the liner is secure.
- () The vent is clear and of acceptable size.
- () No signs of cracks or bending around the trunnions.
- () No signs of weakness at the chaplets on bronze tubes.

The Carriage

- () Wheels are tight and free of rot and insect infestation.
- () Body of the carriage is free of rot and insect infestation.
- () No pieces or parts missing, cracked, bent or broken.
- () Wheels move freely.
- () Elevating mechanism works smoothly and properly.
- () None of the ironwork is coming loose.
- () Tube rotates freely on its trunnions.
- () Trunnion caps fit snugly and are properly keyed.
- () Lids of side boxes and limber chests fit snugly.
- () Limber chests and side boxes are clean and free of spilled powder.
- () Wood is generally free of serious checking and splintering.
- () Wheel hub does not gouge the end of the axletree.
- () Linchpin is not digging into wheel hub.

Equipment

- () All necessary equipment is present.
- () Sponge is in good condition and fitted to the bore.
- () Rammer head is secure and free of cracks.
- () Smaller items are in good condition (linstock, thumbstall, buckets, etc.).
- () Prongs of the worm are sharp and not bent.
- () Haversack is clean and free of spilled powder
- () The gun book is being kept up to date.

Post 1898 Small Arms Inspection Procedures

All weapons (including propane-actuated automatic weapon simulators) will be inspected each day prior to use.

If a weapon fails a safety inspection it must be removed from the event. Repair and re-inspection of weapons that have failed the safety inspection is permitted.

- 1) Verify that the weapon is unloaded - have the reenactor keep the muzzle of the weapon pointed in a safe direction while you verify that the bolt is open, the chamber is clear, and the magazine is empty. Continue to keep the rifle pointed in a safe direction throughout the inspection procedure.
- 2) Check for proper functioning of the weapon's safety features:
 - a) With the hammer or firing pin forward (un-cocked), verify that the safety will **NOT** engage. Note: This test applies to M1 Garands and M1903 rifles, but may not apply to other as-issued military rifles.
 - b) After verifying that the rifle is not loaded, have the reenactor cock the weapon and engage the safety. It should snap into place and the hammer or firing pin must not drop.
 - c) Have the reenactor pull the trigger and verify that that the safety is blocking the release of the trigger, hammer or firing pin.
 - d) Have the reenactor release the trigger and disengage the safety, verifying that the hammer or firing pin does not drop.
 - e) Pull the trigger and verify that the hammer or firing pin drops.

3) Check semi-automatic rifles for proper disconnecter operation. The purpose of this inspection step is to minimize the likelihood of unintended multiple rounds being fired with the single pull of the trigger. Semiautomatic rifles use a disconnecter to do this. The disconnecter prevents the continued firing of the gun while the trigger remains depressed by holding the gun at full cock as long as the trigger is held back.

- a) Verify that the rifle is unloaded and place the safety in the “off” position.
- b) Close the bolt.
- c) Pull the trigger and hold the trigger to the rear without releasing it.
- d) Open the bolt to reset the hammer (while continuing to hold the trigger to the rear), then close the bolt.
- e) Release the trigger (listen for the disconnect click), then pull the trigger again, the hammer should drop if the disconnecter is working properly.
- f) If you hear the click and the hammer drops when you pull the trigger, it passes the test.
- g) If you did not hear the click and the hammer does not drop when you pull the trigger (because it has already followed the bolt forward), the disconnect function is not working correctly and the weapon fails the inspection. It must be removed from the event until repaired and re-inspected.

4) General visual inspection - the purpose of this last step is to detect any obvious problems or other safety concerns.

Post-1898 Small Arms Inspection Checklist

Revolver or Pistol

- () Verify weapon is unloaded.
- () Is the revolver or pistol in good operating condition? Does the safety work?
Does the cylinder rotate and align in the firing position? Is the barrel free of all obstructions?
- () Is the revolver or pistol complete? No missing parts?

Rifle and Carbine

- () Verify weapon is unloaded.
- () Is the rifle in good operating condition? Does the safety work? Does the magazine operate? Is the barrel free of all obstructions?
- () Verify safe function of disconnect on semi-automatic weapons
- () Is the rifle complete? No missing parts?

Shotgun

- () Is the Shotgun in good operating condition? Does the safety work? Does the pump or the lock (in case of a double barrel) work? Is the barrel or barrels free from all obstructions?
- () Is the shotgun complete? No missing parts?

Blank Ammunition

- () Does the blank ammunition have clean brass and primers?
- () Is it a crimped cartridge?
- () Is there anything that would cause a projectile to be shot out of the barrel?
- () Shotgun Ammunition - are they factory loads?

Holsters

- () For handguns, does the holster fit the firearm?
- () Does the holster have a lock down strap or flap?

Ammunition and Web Belts

- () Is the belt complete?
- () Are any cartridges approved blanks or dummies with either an expended primer or no primer and no powder?

Edged Weapons

- () Are all knives, sabers, swords, bayonets in the proper scabbards?
- () Are the edges and tips of display edge weapons blunt?

VISITOR SAFETY

Control

The site Safety Officer shall control and supervise all firing demonstrations and reenactments including those conducted by outside organizations and volunteers.

Weapons Handling by Visitors

Visitors may handle weapons in camp. Visitors must be 17 to handle small arms in the camp area and then only with the permission of the owner. Before any muzzle loading weapon is turned over, the weapon will be examined by the owner to make sure it is unloaded with the hammer (cock) forward in the “fired” position or, in the case of modern weapons, the breech open and the safety in the “on” position. The barrel should be pointed either skyward or toward the ground and away from any person. The owner is responsible for the weapon and is not to leave it unattended while it is out of his/her control.

No charges, cartridges or ammunition may be handled by a visitor.

Edged weapons may not be withdrawn or handled by a visitor.

BARRIERS AND RANGE REQUIREMENTS

Visible or physical barriers such as fences, ropes, ribbons, walls and natural barriers are required to keep visitors at the safe distances indicated on the range specifications section of this document. If natural features are inadequate ropes or other artificial means shall be employed. No visitors will be allowed in front of a line perpendicular to the muzzle of a demonstration weapon except as indicated in alignments for tactical reenactments. The minimum distance between visitors and demonstration weapons is five (5) yards [15 feet] for small arms; Seventeen (17) yards [51 feet] for artillery. Please refer to schematic drawings on pages 28-30.

The diagram below contains the specifications for small arms demonstration firing ranges including distance requirements and crowd control arrangements. Please note that the distances are mandatory but the positioning of weapons and the physical layout can vary based on terrain. *Always err on the side of SAFETY.*

Small Arms Demonstrations

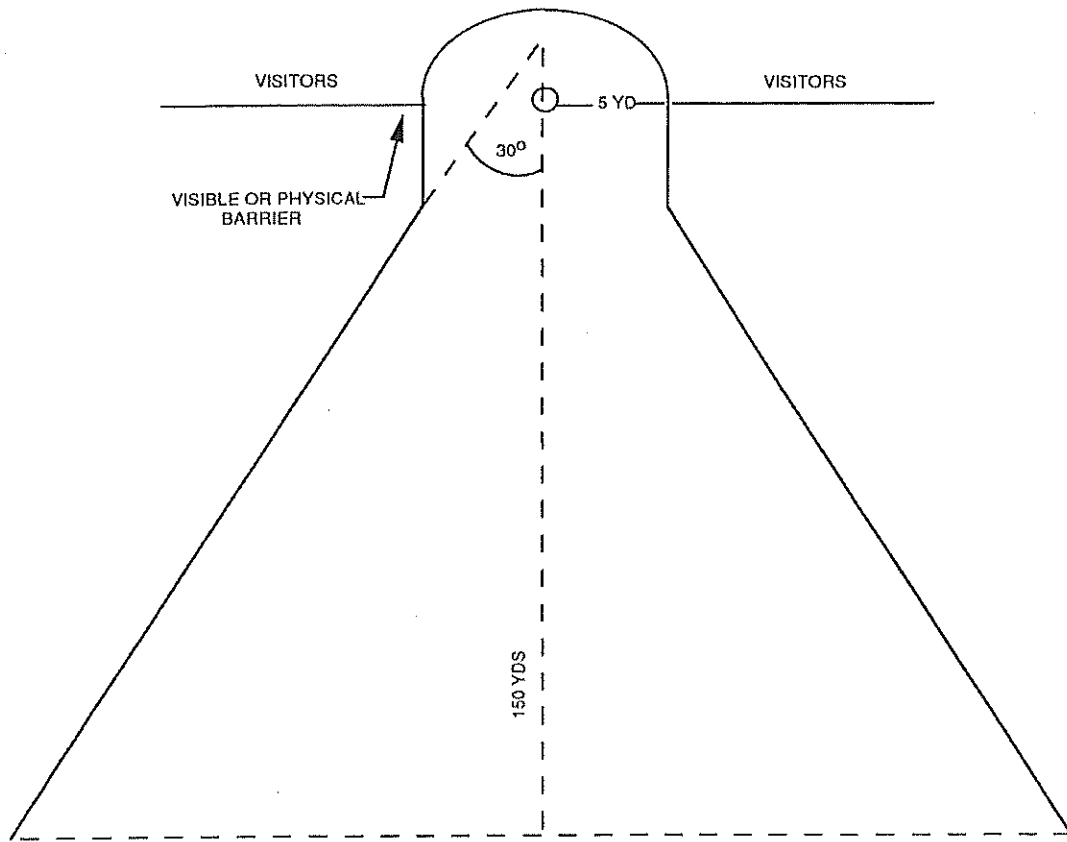

RANGE FOR BLANK SMALL ARMS FIRING DEMONSTRATIONS

The diagram below contains the specifications for artillery demonstration firing ranges including distance requirements and crowd control. Please note that the distances are mandatory but the positioning of weapons and the physical layout can vary based on terrain. *Always err on the side of SAFETY.*

Artillery Demonstrations

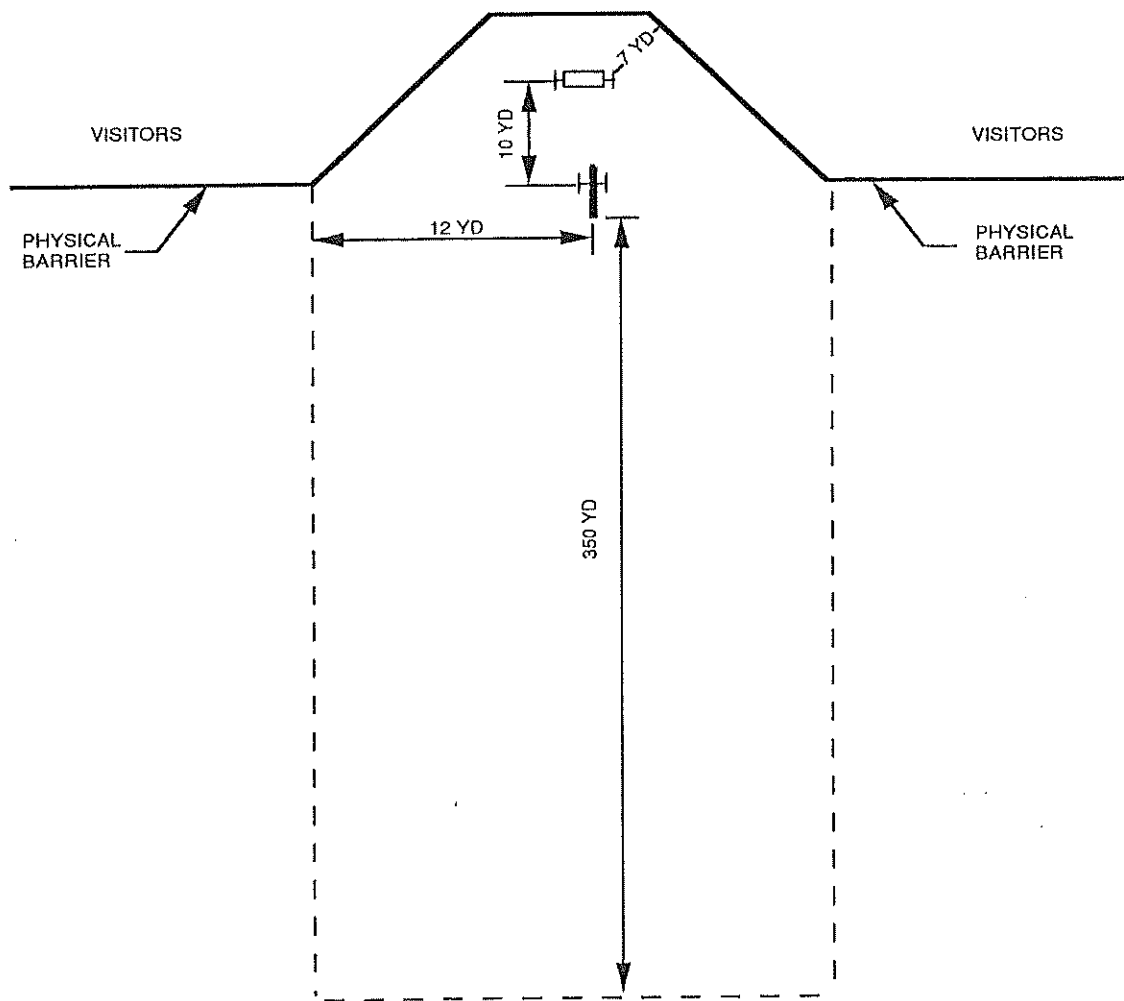

RANGE FOR BLANK CANNON FIRING DEMONSTRATIONS

The following diagram illustrates an example of proper site layout for a battle reenactment with opposing forces.

Opposing Force Battle Reenactment

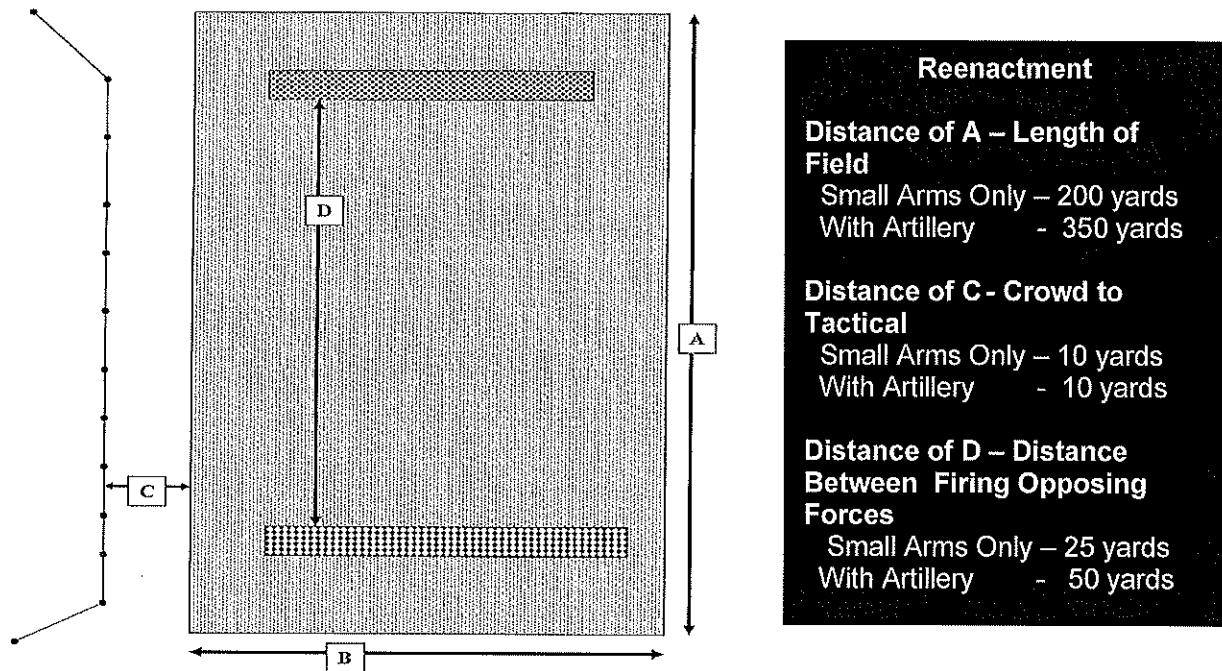

The following conditions **MUST BE MET** in order to have a battle tactical at your site:

- A minimum of 200 yards total tactical area for small arms fire only; minimum of 25 yards for opposing tactical fire between lines
- A minimum of 350 yards total tactical area for opposing line fire with artillery; minimum of 50 yards for opposing tactical fire between lines that support artillery
- No “inhabited areas” in the field of fire, (includes houses, public roads, site visitor buildings, and other structures typically viewed as inhabited)
- A minimum of 10 yards distance must be maintained at all times between the spectator and the outside edge of the battle line when perpendicular to each other
- No visitors to the front or rear of opposing forces
- Artillery to fire from fixed positions to be established prior to the commencement of the event.
- Opposing forces with small arms will not fire at ranges closer than 25 yards
- Artillery will not fire at an opposing force that closes to less than 50 yards.

Firing Procedures and Personal Safety

Weapons will be discharged above the head of the opposing force at a 45-degree angle unless otherwise dictated by the terrain of the engagement or the judgment of the Safety Officer in charge of the event. The face will always be kept clear of the muzzle of the weapon.

During an opposing force battle reenactment, no paper wadding or any foreign material other than black powder or a blank metallic cartridge shall be put into the firing chamber of the gun. No ramrod will be withdrawn during opposing force battle reenactments unless instructed by the site Safety Officer. A designated NCO or Officer for each side may withdraw a ramrod to clear an obstruction or charge in the designated safety area only, and only with the permission of a site Safety Officer.

During non-opposing forces firearms demonstrations, charges may be rammed, but a charge shall not be rammed home with the palm of the hand. Safety glasses and ear protection shall be worn by site or museum employees who are demonstrating weapons, and are strongly suggested for non-employees and volunteers (PHMC ONLY).

CONDUCT OF FIRING DEMONSTRATIONS BLACK POWDER SMALL ARMS

Each individual and/or group shall receive a copy of the Commission's regulations at least two weeks prior to conducting firing demonstrations at the site or museum. It is the responsibility of the individual or unit to review the Commission regulations and certify in writing that they have read the regulations and agree to adhere to them. A unit is defined as the actual reenactment unit and not a larger association of several units such as the B.A.R., for example. The written verification must be received at least two days prior to the demonstration or the individual and/or group will not be permitted to conduct firing demonstrations.

Loading

All loading of weapons will be done from pre-prepared cartridges.

Powder horns and flasks will be used for priming only and shall not contain more than two ounces of black powder.

Cartridge boxes shall hold the cartridges securely so that they will not fall out during times of heavy activity.

Black powder spilled in the demonstration area should not be allowed to accumulate. Excess powder should be soaked with water several times.

Weapons

Only historically accurate weapons designated for use at the site or museum shall be fired.

All weapons shall pass the required inspection or will be removed from the demonstration area.

All employees, volunteers, reenactors and/or reenactment units wishing to demonstrate arms at the Commission's historic sites and museums shall be authorized to do so in writing by the Safety Officer at least two weeks prior to the demonstration.

CONDUCT OF FIRING DEMONSTRATIONS BLACK POWDER ARTILLERY

Only reproduction artillery pieces will be fired. Prior to firing all artillery pieces must successfully pass the artillery inspection checklist contained herein (page 26).

Swivel guns of a bore diameter 1 inch or larger must be served by a gun crew of at least 3 members; a field piece (i.e. mounted upon a carriage) shall have a minimum crew of 5 members.

Each artillery piece must be properly equipped with a pick, rammer, worm, sponge and water bucket. Ammunition must be properly stored in a secure limber chest.

Each individual and/or group shall receive a copy of the Commission's regulations at least two weeks prior to conducting firing demonstrations at the site or museum. It is the responsibility of the individual or unit to review the Commission regulations and certify in writing that they have read the regulations and agree to adhere to them. A unit is defined as the actual reenactment unit and not a larger association of several units such as the B.A.R., for example. The written verification must be received at least two days prior to the demonstration or the individual and/or group will not be permitted to conduct firing demonstrations.

The proper placement of artillery will be determined by the Safety Officer in consultation with the commanding officers of the participating units before the event. Artillery will not be moved from the approved location(s) without the approval of the Safety Officer prior to the actual demonstration.

A minimum of *three minutes* of time must pass between firing and loading during which time the bore will be thoroughly swabbed and wormed. Neither rapid fire nor live (projectile) firing is permitted. No wadding will be used.

Before:

- () The gun has been inspected, inside and out.
- () Bore is clean of foreign material.
- () The gun crew has demonstrated their knowledge of and ability to adhere to the position responsibilities outlined in a standard artillery manual of arms.
- () The carriage is in good condition and all keys are secure.
- () The accessory equipment is in good condition--sponge head in good repair, rammer and sponge secure on staff, etc.
- () Sponge head fits bore snugly but not too tight.
- () Ammunition boxes, haversacks, etc., are clean and free of spilled powder.

- () Ammunition is properly prepared, with just enough on hand for one demonstration.
- () The equipment is on hand to handle a misfire.
- () Required number of personnel are present to safely fire the piece.
- () The gun is situated safely in relation to the visitors.
- () The interpreter can see all of the visitors and can also see downrange.
- () The carriage is free to recoil if necessary so it won't buck, break, or collide with anything.
- () The visitors are properly contained, are located at a safe distance, and have good visibility so there will be no jostling and pushing to see and hear.
- () The ammunition boxes or limbers are located at a safe distance from the piece as well as from the visitors.
- () Conditions are not so dry as to risk a range fire from the muzzle blast.
- () Equipment is available should a range fire develop.
- () There is a first aid kit and emergency communications system available.
- () There are no open fires nearby--campfires, etc.

During:

- () The gun crew is following the approved manual with each crewmember located where they are supposed to be.
- () The sponge is adequately damp but not soaking wet
- () The man ramming is holding the rammer properly and the vent is being properly tended at the same time.
- () The rammer man is wearing gauntlets, but they are not so stiff and heavy as to cause fumbling or other difficulty.
- () The sponge head does not contact the ground at any time during the demonstration to prevent grass, sand, etc., from sticking to it.
- () If there is a misfire, it is handled safely and properly.

After:

- () After firing, the piece is wormed, sponged out, and dried.
- () All weapons, explosives, and accessory pieces are accounted for.
- () The weapon is secured and stored properly.
- () Demonstration area is inspected for smoldering residue.
- () Sponge head is thoroughly rinsed and dried.
- () All remaining explosives are promptly returned to proper storage area.

CONDUCT OF FIRING DEMONSTRATIONS POST-1898 SMALL ARMS

All modern small arms being used in a weapons demonstration shall be submitted to the same inspection requirements as weapons used in a tactical reenactment.

Any weapon that fails the safety inspection twice prior to the demonstration shall be removed from the demonstration.

In the event of a misfire, the weapon will be removed a safe distance from the spectators and the misfired shell will be ejected from the receiver – the shell will be given to the site Safety Officer for disposal.

Any weapon that jams will be removed to a location away from the spectators and repaired.

No weapon will be handled by the spectators or removed from the demonstration area until it has been cleared by the on-site Safety Officer as being empty.

CONDUCT OF OPPOSING FORCE REENACTMENTS

In addition to the other regulations in this manual, the requirements for simulating the combat scenarios listed below will be followed.

The tactical engagement area will be pre-determined by the site administrator or his designee, the site Safety Officer, and the participating unit commanders. Distances will conform to the best practices as prescribed by the PHMC Historic Weapons Safety Manual. Site Safety Officers have the right to increase those minimum distances if they feel the tactical safety zones are inadequate.

A physical safety barrier of not less than 10 yards will be erected between the visitors and the engagement area. There will be no weapons discharged from within the safety zone.

Ramrods may be carried in a battle reenactment but they **will not** be withdrawn from the pipes except upon instruction by the site Safety Officer.

Edged weapons will not be drawn except as symbols of rank and ceremony.

No hand to hand combat or atrocities will be permitted.

Combatants will stay with their units and follow officers' orders. They know the battle plan.

If enemy charges and will not stop - give way or fall down.

If charging and the enemy does not give way - stop.

If portraying a wounded or killed combatant do not rise again until the engagement is over.

Do not fire or strike at an enemy who is too close - fall down or give way.

Never disturb an artillery crew!

Only paper cartridges without staples or other fasteners will be used to load arms. For artillery: aluminum foil cartridges.

After a demonstration or reenactment, the designated area will be policed by site personnel for spent and live cartridges or charges. All material will be collected in paper bags, soaked in water and properly disposed of. **DO NOT BURN SPENT CARTRIDGES!**

USE OF MOTORIZED VEHICLES IN DEMONSTRATIONS AND REENACTMENTS

All motor vehicles must be driven by a licensed driver, regardless if used on or off road. The driver must be knowledgeable of the type of vehicle he is driving. Proper liability insurance is mandatory. All vehicle owners must submit a copy of their insurance card for inspection prior to the event.

Vehicle operators must adhere to all Federal, state and local vehicle regulations.

All vehicles must be either original to their time period or acceptable reproductions.

Maximum vehicle speed on the battlefield is **10 mph**.

Any vehicle driven off road shall have a ground guide to avoid personnel hiding in brush and foliage.

No weapon is to be fired directly at anyone in a vehicle.

Vehicles are subject to a safety inspection prior to participation to verify the following:

- a. Service brakes function on all wheeled vehicles.

- b. Emergency brakes (parking brakes) function if so equipped.
- c. Steering system is functional.
- d. Lighting systems are functional.
- e. Each vehicle shall be equipped with a current UL listed class BC fire extinguisher, rated for vehicular fires.
- f. Batteries are properly secured to the vehicle.

Equines, Livestock and Associated Equipment

Equines (horses, mules, and donkeys) can pose safety issues to the public. The following regulations govern the handling and use of equines in military history demonstrations and reenactments on PHMC property.

General Rules

All equine participants and units must preregister with the Site Administrator prior to the event and arrival on site.

Reenactors, owners, and guests are responsible for the care, safety and actions of their animals and may be held accountable for failure to comply. A rider must verify that they have been properly trained before using an equine on PHMC property. If they do not have a certification from their unit, then they must pass an inspection before participating in the event by an appointed Safety Officer or the Site Manager to show their ability to saddle, mount and control their animal beforehand.

Equines will not be left alone at any time while the public is on site. It will be the owner's responsibility to picket or corral all equines when not in use.

Owners will need to comply with all applicable PA Dept. of Agriculture rules and regulations regarding the health and transportation of livestock.

The rider is responsible for knowing and understanding where designated campsites and designated trails are located.

Equines and riders must camp in designated horse areas.

Equines may be tethered to the stock trailer.

Equines must not be tethered to trees, shrubs, or other site structures while in camp.

Hay bags should be used for feeding all livestock.

Manure and hay must be raked and bagged before leaving the campsite for later disposal off site.

No stallions are permitted for reenacting and living history events.

Participants may not allow visitors to mount or ride animals at any time.

Picket Lines and Corrals

Picket lines will be used with a strong rope tied between two trees. There will not be any "picket pens" used other than display. Horses on picket lines should be tied to prevent the head from being lowered below the horse's chest. They should not be able to step over the picket line. If a picket line is arranged for the horse to graze (where the horse could step over the rope), then only one horse should be tied to the picket line at any given time.

Corrals will have room for horses, water and feed (hay and grain).

Picket lines will be roped off with a boundary of at least twenty feet on all sides.

There will be someone on guard with the animals in picket or the corral whenever the public has access to the area.

Equipment

Saddles, halters, and bridles are to be kept in a safe usable condition. Poorly maintained equipment can be dangerous to the animal and rider and will not be allowed.

Conduct of Cavalry Demonstrations and Reenactments

The following safety standards and procedures are to be utilized by all reenactment units and individuals while on property owned and/or operated by the site. These are minimum standards.

Horses, men, and equipment not assigned to artillery should stay a minimum of 25 feet away from artillery caissons and powder lockers at all times.

Gunpowder will be carried in pre-rolled cartridges, extra cylinders or small, approved flasks only. Individuals will carry no large cans of powder, either as riders or as foot troops.

Pistols will be carried with the hammer between chambers or on an empty cylinder. Carbines, rifles, and shotguns will be carried in a similar manner.

Caps will be kept in a cap box or "capper."

Loads: Wadding will not be used to pack gunpowder.

Edged weapons such as swords and sabers will be kept elevated when in used in a battle or engagement.

All knives, axes, tomahawks, polearms, swords and bayonets used for demonstration shall have dulled edges and blunted points.

All mounted “live fire” (demonstration shooting) will be approved and reviewed by the Safety Officer before the demonstration is performed.

All equines will be controlled during “live fire” exercises by their riders or by dismounted troops.

Riders will keep a distance of 10 yards or more from the public when mounted.

MISFIRE PROCEDURES

Misfires: Black Powder Small Arms

During a demonstration, if a small arms weapon fails to discharge, the demonstration will immediately halt. Demonstrators and visitors will be instructed to hold their positions. The site Safety Officer will explain the situation to the visitors, move them to a safe distance, and supervise the demonstrator in clearing the weapon. The weapon will be re-primed and fired. This procedure may be repeated. If the weapon fails to fire after the third attempt the cock will remain in the full forward position, the pan will be emptied, and the hammerstall placed on the frizzen. The weapon will then be removed from the field, maintaining the five-yard distance requirement from any visitors, with the muzzle pointing directly up. The designated Safety Officer will accompany the demonstrator as the weapon is removed. The firing demonstration will cease until the return of the designated Safety Officer unless another is present.

In a secure area, removed from any visitors, the flint may be adjusted or replaced, the vent picked, frizzen cleaned, and the piece discharged. If this fails, the weapon will be discharged with a CO2 discharger or flushed with water poured into the bore, taking care to keep the muzzle pointed in a safe direction. If a discharger is used, the weapon will be discharged into an appropriate backstop and all foreign material will be collected and properly disposed of. If flushing is used, the flushing will continue until the water exiting the vent is clear. The barrel will then be wormed to remove any portions of the cartridge or other foreign material and flushed once more. However, in the event the vent is clogged and water poured in the bore cannot exit, the vent may be picked while the barrel is full of water. When the water flows clear,

the weapon may be subsequently wormed. Once the weapon has been cleared, cleaned and re-inspected, it may be returned to active use.

Misfires: Black Powder Artillery

In the event of artillery misfire the audience will be informed that the weapon has misfired and will be told the basic procedures for clearing that misfire. **The artillery crew will wait a minimum of three minutes before re-priming and firing the piece.** If the piece fails to fire a second time, the demonstration/reenactment will be stopped; the audience will be removed from the demonstration/reenactment area to a minimum distance of 300 feet. After three minutes and with the permission of the Safety Officer, the procedure for clearing the weapon may begin. Minimum procedure is to elevate and flood the bore of the tube and the vent with water and worm the charge from the bore. Preferred procedure is to discharge the powder into an appropriate backstop using a properly fitted CO2 discharger. Spent or foreign material will be collected and disposed of properly. Once the charge has been removed and the vent cleared, the piece may be cleaned, re-inspected, and if passed, returned to service.

Misfires: Post-1898 Small Arms

If a metallic cartridge weapon fails to fire during a demonstration or battle tactical, the safety (if the weapon is so equipped) will be engaged and the cartridge removed from the firing chamber. The cartridge will be marked as a "dud" and placed in a separate pocket or cartridge container so as not to be reused. Any cartridge with a dimpled primer is not to be reused for firing.

If a metallic cartridge weapon jams during a demonstration and cannot be un-jammed without tools, demonstrators and visitors will be instructed to hold their positions. The site safety officer will explain the situation to the visitors, move them to a safe distance and supervise the demonstrator in clearing the weapon. If the weapon cannot be cleared, the demonstration will be halted and the weapon will be removed from the field and properly cleared in a designated safety area. The weapon must be re-inspected before it is permitted back onto the field.

During a battle reenactment if a cartridge weapon jams the demonstrator will either assume a position where the weapon will no longer be operated or will remove the weapon from the field to be cleared as stated above. The site Safety Officer will be notified and the weapon will be taken to a designated safe area away from visitors where the weapon can be properly cleared, re-inspected and returned to the engagement.

GLOSSARY

Artillery: Historic weapons with a bore diameter of 1" or larger.

Belly Box: A wooden block with leather flap used to hold paper cartridges. Commonly worn on a belt around the waist.

Blank Firing Adapter (BFA): A device affixed to a gas-operated metallic cartridge firing weapon which allows the semi-automatic action to cycle a new cartridge into the firing chamber of the weapon.

Bore: Inside diameter of the barrel of an historic weapon. A bore diameter of 1/2 inch = 50 caliber; of 3/4 inch = .75 caliber; etc...

Cartridge: Container, most commonly of paper, used to hold a measured amount of black powder. In the case of artillery, aluminum foil is often used.

Cartridge Box: Leather pouch worn over the shoulder which contains a wooden block with holes that accept pre-made paper cartridges.

Cock or Hammer: That part of a firelock weapon that holds the flint and travels forward when the trigger is pulled causing the flint to strike the face of the frizzen and thus create sparks.

Demonstration: a program or event that incorporates the demonstration of a weapon type, tactical system, line of march, etc. as portrayed by a person or unit with no opposing force.

Edged Weapon: All manner of swords, bayonets, knives and belt axes.

Former: Wooden dowel used to roll paper cartridges. It is sized to the bore of the weapon for which the cartridges are made.

Flash: Term for the rapid burning of the gun powder that has been placed in the pan of a firelock weapon.

Flash Guard: Brass or steel device that directs the flash from the lock of a musket or rifle upward and away from nearby soldiers and visitors.

Frizzen: Hardened steel device on the firelock weapon that when struck by the flint yields sparks which in turn ignite the gun powder placed in the pan of the weapon

Hammerstall: Leather sleeve that fits snugly over the frizzen of a firelock weapon to prevent accidental ignition.

Limber Chest: Historic wooden box to hold artillery ammunition.

Linstock: Historic equipment to discharge cannons. Consists of a rope that has been soaked in saltpeter and wrapped around a piece of wood. It is in effect a slow burning match. The burning end of the rope is used to ignite the quill primer and thus fire the weapon.

Metallic Blank Cartridge: A blank cartridge, crimped or plugged at one end with a center or rim fire primer, used in modern cartridge weapons.

Misfire: When an historic artillery piece or small arm fails to discharge properly while loaded.

Pan: Depression on the lock of a firelock weapon that is adjacent to the vent hole in the barrel. Priming gun powder is placed in the pan. Sparks from the flint striking the frizzen fall into the

pan igniting the priming powder. Part of the fire in the pan travels through the vent hole to ignite the main charge in the barrel.

Powder Flask: Historic metallic container for storing black powder.

Powder Horn: Historic container for storing black powder.

Quill Primer: A goose quill or paper soda straw laced with black powder which is inserted in the vent hole of a cannon or other artillery. The primer carries the fire from the linstock to the main charge in the barrel.

Reenactment: A tactical demonstration between opposing forces on the field of battle. Often incorporates volunteers or non-paid PHMC staff in a volunteer capacity.

Safety Officer: A designee of the Pennsylvania Historical and Museum Commission who has been trained and certified to supervise historic weapons demonstrations and in enforcing the applicable PHMC regulations.

Small Arms: Historic weapons with a bore diameter of less than 1”.

Type 3 and 4 Box Magazine: See BATF Regulations and Construction Documents.

Vent Hole: Hole through the barrel of a firelock weapon or historic cannon.